

MIRELLA-G2-M

~25° wide beam. Compatible with LEDiL HEKLA.

TECHNICAL SPECIFICATIONS:

Dimensions	Ø 49.9 mm
Height	22.6 mm
Fastening	socket
ROHS compliant	yes ⓘ

MATERIAL SPECIFICATIONS:

Component	Type	Material	Colour	Finish	Coating
MIRELLA-G2-M	Reflector	PC	metal		



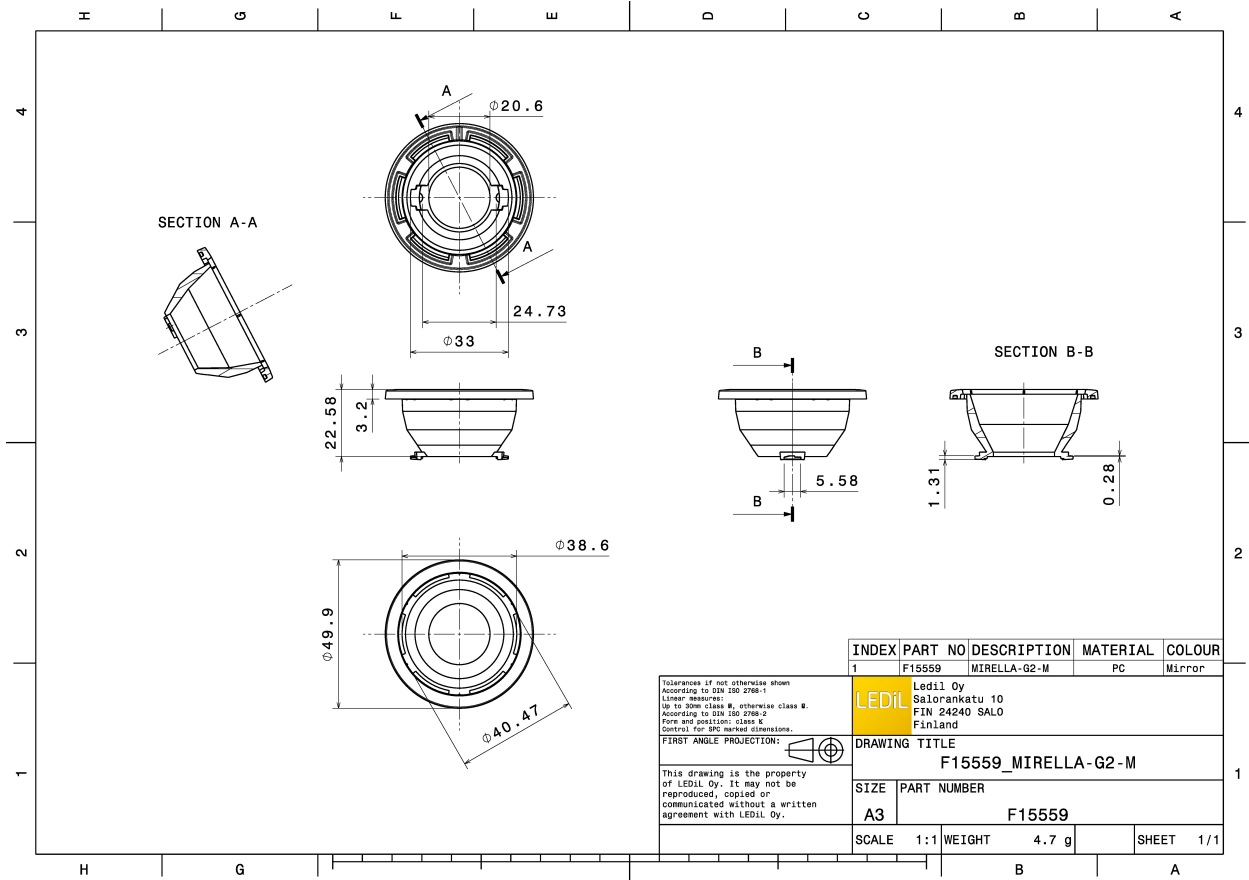

ORDERING INFORMATION:

Component	Qty in box	MOQ	MPQ	Box weight (kg)
F15559_MIRELLA-G2-M » Box size: 480 x 280 x 300 mm	336		28	3.2





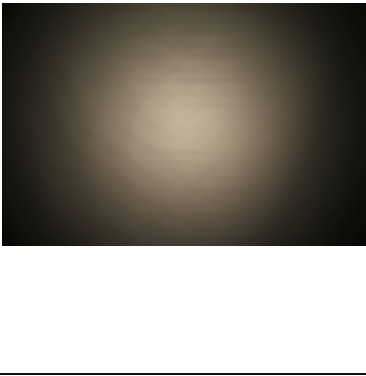
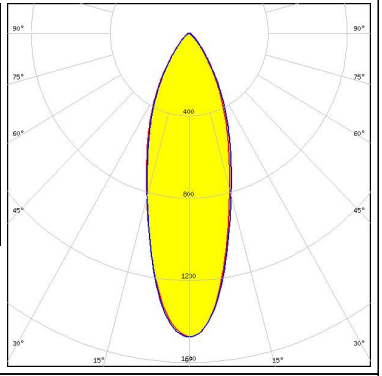

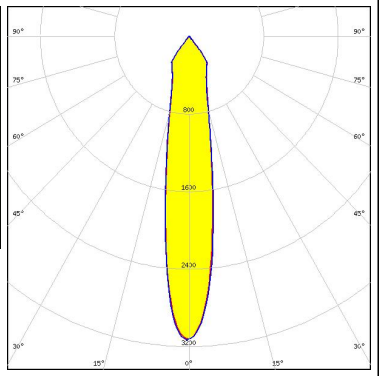
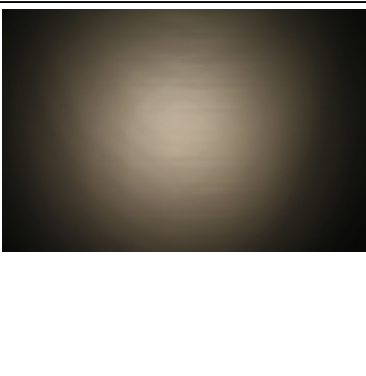
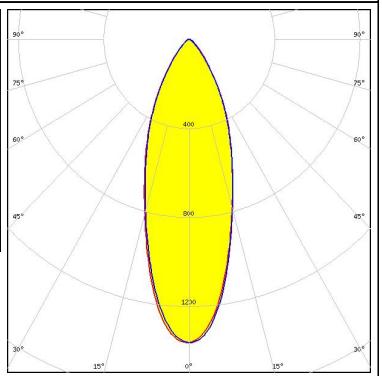
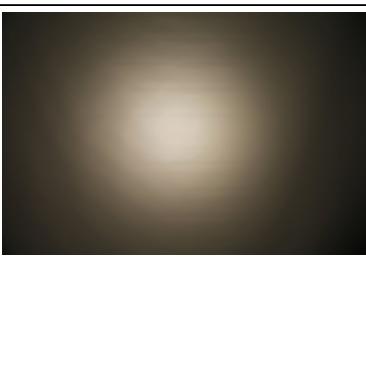
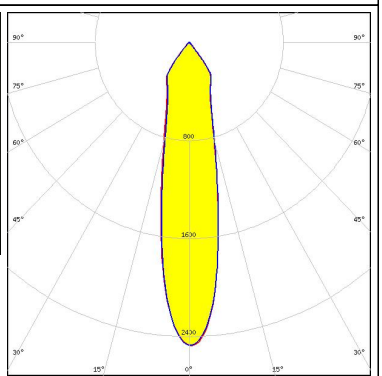

See also our general installation guide: www.ledil.com/installation_guide

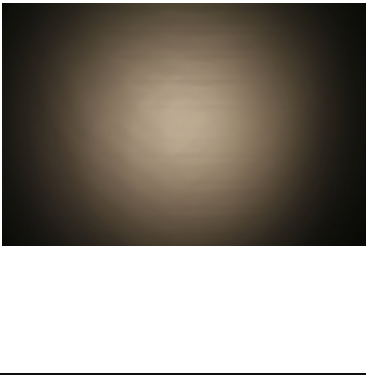
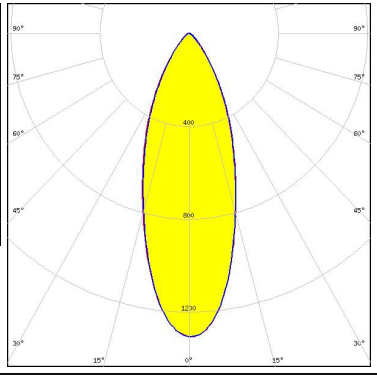

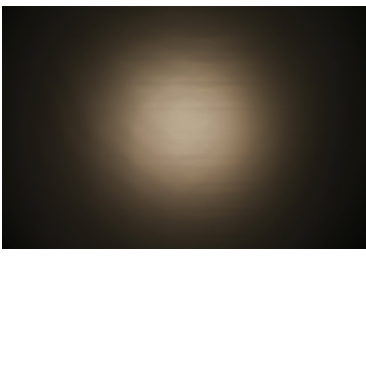
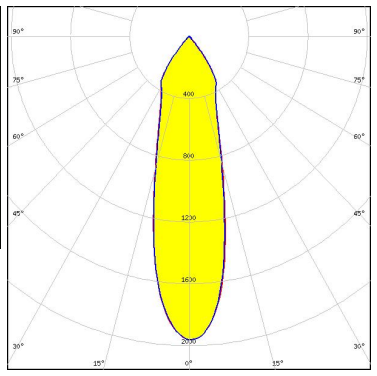

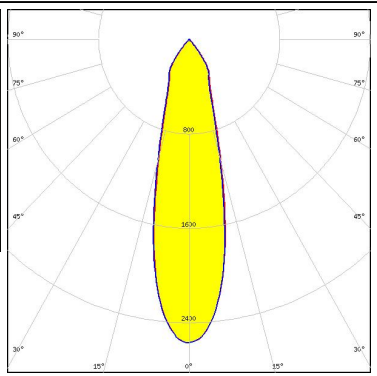

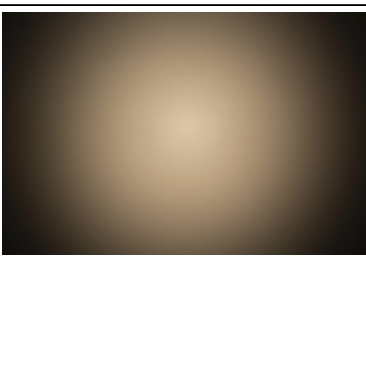
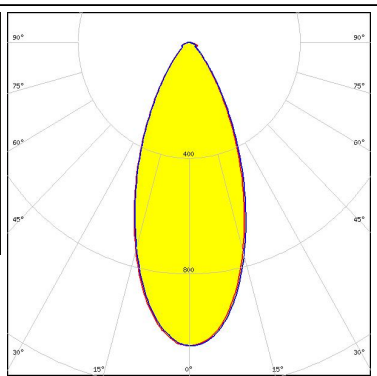

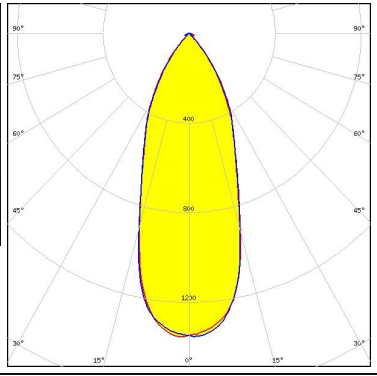

PHOTOMETRIC DATA (MEASURED):

<p>bridgelux.</p> <p>LED V4 HD</p> <p>FWHM / FWTM 33.0° / 75.0°</p> <p>Efficiency 78 %</p> <p>Peak intensity 1.5 cd/m</p> <p>LEDs/each optic 1</p> <p>Light colour White</p> <p>Required components:</p> <p>F15253_HEKLA-SOCKET-A</p> <p>C13723_MIRELLA-RZL</p>		
<p>bridgelux.</p> <p>LED V4 HD</p> <p>FWHM / FWTM 19.0° / 73.0°</p> <p>Efficiency 86 %</p> <p>Peak intensity 3.1 cd/m</p> <p>LEDs/each optic 1</p> <p>Light colour White</p> <p>Required components:</p> <p>F15253_HEKLA-SOCKET-A</p>		
<p>bridgelux.</p> <p>LED V6 HD</p> <p>FWHM / FWTM 35.0° / 77.0°</p> <p>Efficiency 76 %</p> <p>Peak intensity 1.4 cd/m</p> <p>LEDs/each optic 1</p> <p>Light colour White</p> <p>Required components:</p> <p>F15255_HEKLA-SOCKET-C</p> <p>C13723_MIRELLA-RZL</p>		
<p>bridgelux.</p> <p>LED V6 HD</p> <p>FWHM / FWTM 22.0° / 74.0°</p> <p>Efficiency 84 %</p> <p>Peak intensity 2.5 cd/m</p> <p>LEDs/each optic 1</p> <p>Light colour White</p> <p>Required components:</p> <p>F15255_HEKLA-SOCKET-C</p>		

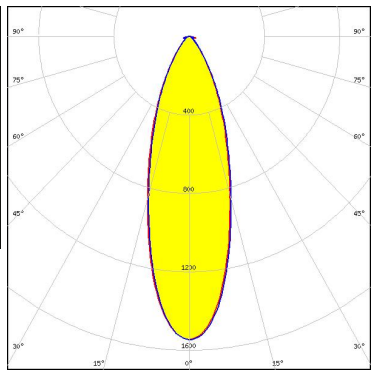

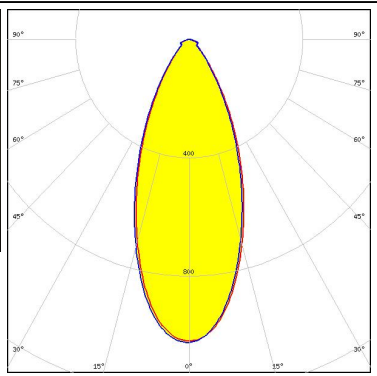





PHOTOMETRIC DATA (MEASURED):

<p></p> <p>LED V9 HD FWHM / FWTM 37.0° / 77.0° Efficiency 75 % Peak intensity 1.3 cd/lm LEDs/each optic 1 Light colour White</p> <p>Required components: F15859_HEKLA-SOCKET-I C13723_MIRELLA-RZL</p>		
<p></p> <p>LED V9 HD FWHM / FWTM 27.0° / 76.0° Efficiency 82 % Peak intensity 2 cd/lm LEDs/each optic 1 Light colour White</p> <p>Required components: F15859_HEKLA-SOCKET-I</p>		
<p></p> <p>LED VERO10 FWHM / FWTM 27.0° / 71.0° Efficiency 90 % Peak intensity 2.6 cd/lm LEDs/each optic 1 Light colour White</p> <p>Required components: F15616_HEKLA-SOCKET-F</p>		
<p></p> <p>LED Vesta DTW 13mm (21W) FWHM / FWTM 43.0° / 81.0° Efficiency 73 % Peak intensity 1 cd/lm LEDs/each optic 1 Light colour Tunable White</p> <p>Required components: C16142_HEKLA-SOCKET-K C13723_MIRELLA-RZL Bender Wirth: 491 Typ L8</p>		

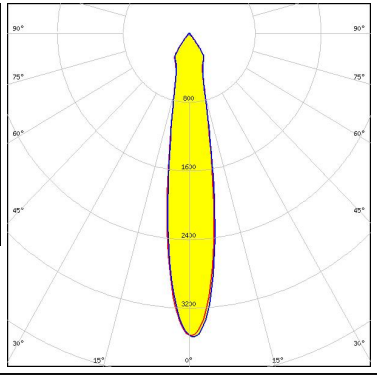
PHOTOMETRIC DATA (MEASURED):

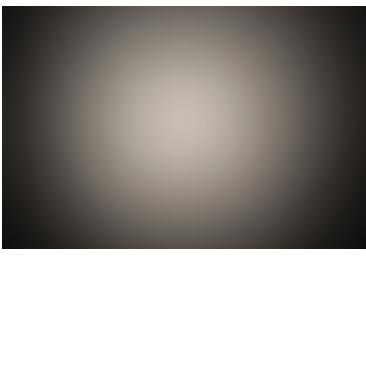
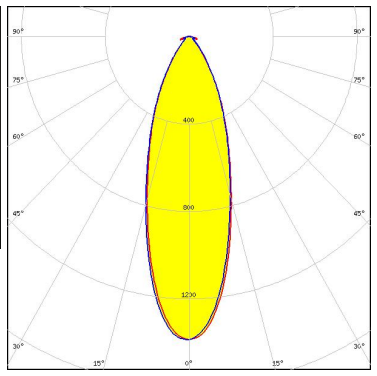
<p></p> <p>LED Vesta DTW 13mm (21W) FWHM / FWTM 39.0° / 78.0° Efficiency 81 % Peak intensity 1.4 cd/lm LEDs/each optic 1 Light colour Tunable White</p> <p>Required components: C16142_HEKLA-SOCKET-K Bender Wirth: 491 Typ L8</p>		
<p></p> <p>LED Vesta DTW 9mm (4W/6W/12W) FWHM / FWTM 33.0° / 70.0° Efficiency 77 % Peak intensity 1.5 cd/lm LEDs/each optic 1 Light colour White</p> <p>Required components: C16142_HEKLA-SOCKET-K C13723_MIRELLA-RZL Bender Wirth: 490 Typ L8</p>		
<p></p> <p>LED Vesta TW 13mm (25W) CSP FWHM / FWTM 43.0° / 81.0° Efficiency 77 % Peak intensity 1 cd/lm LEDs/each optic 1 Light colour White</p> <p>Required components: C16142_HEKLA-SOCKET-K C13723_MIRELLA-RZL Bender Wirth: 492 Typ L8</p>		
<p></p> <p>LED Vesta TW 6mm DP FWHM / FWTM 29.0° / 71.0° Efficiency 74 % Peak intensity 1.6 cd/lm LEDs/each optic 1 Light colour White</p> <p>Required components: C16142_HEKLA-SOCKET-K C13723_MIRELLA-RZL Bender Wirth: 504 Typ L8</p>		

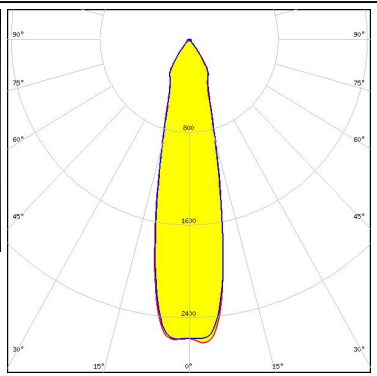
PHOTOMETRIC DATA (MEASURED):

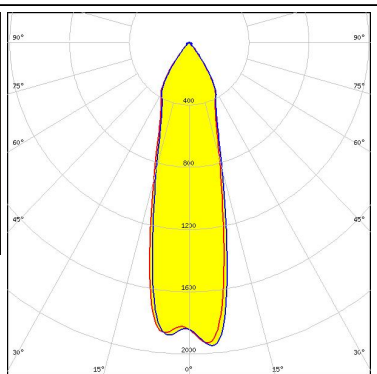
<p></p> <p>LED Vesta TW 6mm DP</p> <p>FWHM / FWTM 18.0° / 58.0°</p> <p>Efficiency 81 %</p> <p>Peak intensity 3.5 cd/lm</p> <p>LEDs/each optic 1</p> <p>Light colour White</p> <p>Required components: C16142_HEKLA-SOCKET-K Bender Wirth: 504 Typ L8</p>		
<p></p> <p>LED Vesta TW 9mm (12W) CSP</p> <p>FWHM / FWTM 33.0° / 73.0°</p> <p>Efficiency 74 %</p> <p>Peak intensity 1.4 cd/lm</p> <p>LEDs/each optic 1</p> <p>Light colour White</p> <p>Required components: C16142_HEKLA-SOCKET-K C13723_MIRELLA-RZL Bender Wirth: 489 Typ L8</p>		
<p></p> <p>LED Vesta TW 9mm (12W) CSP</p> <p>FWHM / FWTM 25.0° / 68.0°</p> <p>Efficiency 84 %</p> <p>Peak intensity 2.6 cd/lm</p> <p>LEDs/each optic 1</p> <p>Light colour White</p> <p>Required components: C16142_HEKLA-SOCKET-K Bender Wirth: 490 Typ L8</p>		
<p>CITIZEN</p> <p>LED CLC020 Series (Dim-To-Warm)</p> <p>FWHM / FWTM 28.0° / 72.0°</p> <p>Efficiency 80 %</p> <p>Peak intensity 2 cd/lm</p> <p>LEDs/each optic 1</p> <p>Light colour White</p> <p>Required components: C16142_HEKLA-SOCKET-K</p>		

PHOTOMETRIC DATA (MEASURED):

CITIZEN

LED CLC020 Series (Dim-To-Warm)
 FWHM / FWTM 36.0° / 74.0°
 Efficiency 74 %
 Peak intensity 1.3 cd/lm
 LEDs/each optic 1
 Light colour White
 Required components:
 C16142_HEKLA-SOCKET-K
 C13723_MIRELLA-RZL
 Bender Wirth: 487 Typ L8

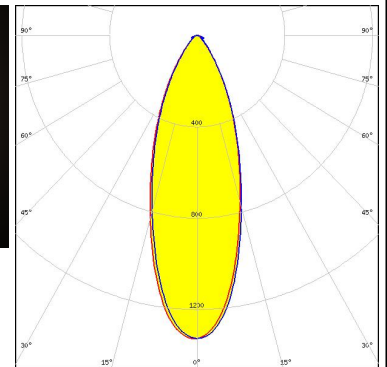
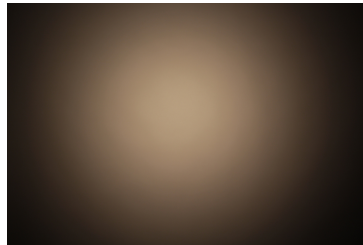

CITIZEN

LED CLU025/CLU027 (LES 6)
 FWHM / FWTM 20.0° / 59.0°
 Efficiency 87 %
 Peak intensity 3.4 cd/lm
 LEDs/each optic 1
 Light colour White
 Required components:
 F15255_HEKLA-SOCKET-C

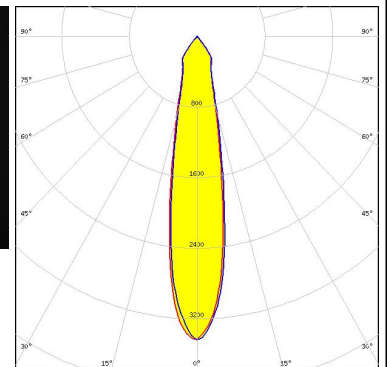

CITIZEN

LED CLU025/CLU027 (LES 6)
 FWHM / FWTM 21.0° / 55.0°
 Efficiency 86 %
 Peak intensity 3.5 cd/lm
 LEDs/each optic 1
 Light colour White
 Required components:
 F15255_HEKLA-SOCKET-C

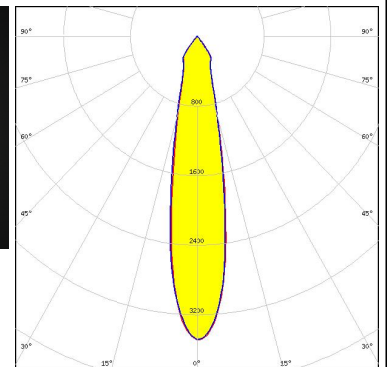
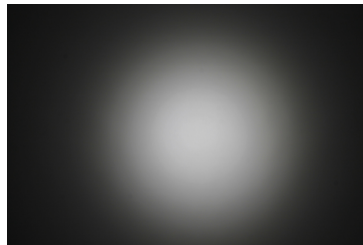

CITIZEN

LED CLU700/701/702
 FWHM / FWTM 19.0° / 50.0°
 Efficiency 90 %
 Peak intensity 4 cd/lm
 LEDs/each optic 1
 Light colour White
 Required components:
 F15255_HEKLA-SOCKET-C

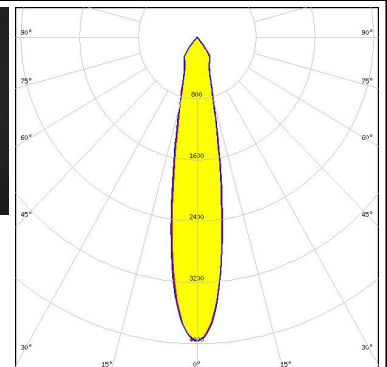
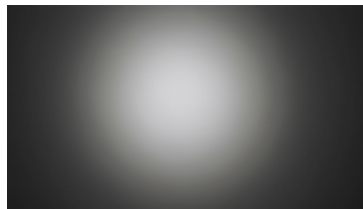

PHOTOMETRIC DATA (MEASURED):

CITIZEN

LED CLU700/701/702
 FWHM / FWTM 19.0° / 49.0°
 Efficiency 90 %
 Peak intensity 4 cd/lm
 LEDs/each optic 1
 Light colour White
 Required components:
 F15255_HEKLA-SOCKET-C

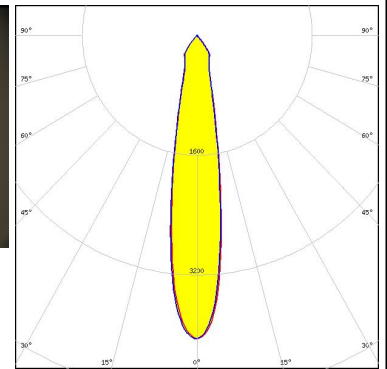

CITIZEN

LED CLU710/711
 FWHM / FWTM 26.0° / 73.0°
 Efficiency 85 %
 Peak intensity 2.3 cd/lm
 LEDs/each optic 1
 Light colour White
 Required components:
 F15859_HEKLA-SOCKET-I

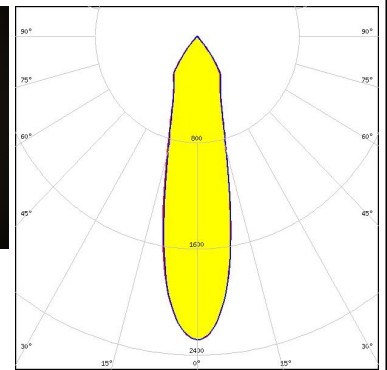
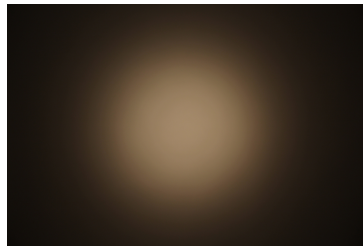

CITIZEN

LED CLU7A2 (LES 4.2mm)
 FWHM / FWTM 16.0° / 49.0°
 Efficiency 87 %
 Peak intensity 4.2 cd/lm
 LEDs/each optic 1
 Light colour White
 Required components:
 F15255_HEKLA-SOCKET-C

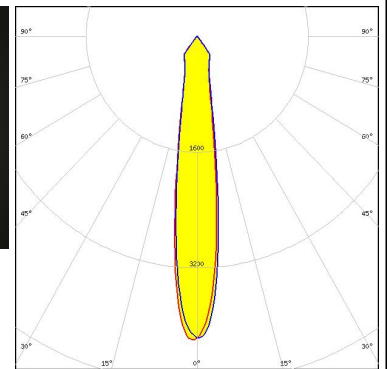
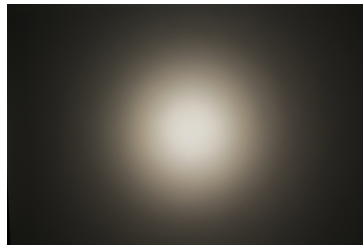

CITIZEN

LED LCN-C01B (Tunable White)
 FWHM / FWTM 35.0° / 70.0°
 Efficiency 75 %
 Peak intensity 1.5 cd/lm
 LEDs/each optic 1
 Light colour White
 Required components:
 C16142_HEKLA-SOCKET-K
 C13723_MIRELLA-RZL
 Bender Wirth: 481 Typ L8

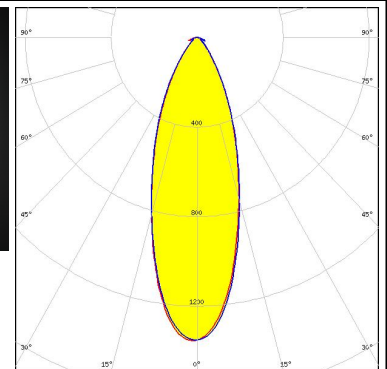
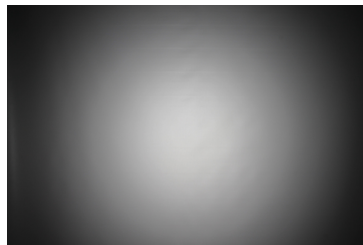

PHOTOMETRIC DATA (MEASURED):

CITIZEN

LED LCN-C01B (Tunable White)
 FWHM / FWTM 35.0° / 74.0°
 Efficiency 75 %
 Peak intensity 1.4 cd/lm
 LEDs/each optic 1
 Light colour White
 Required components:
 C16142_HEKLA-SOCKET-K
 C13723_MIRELLA-RZL
 Bender Wirth: 481 Typ L8

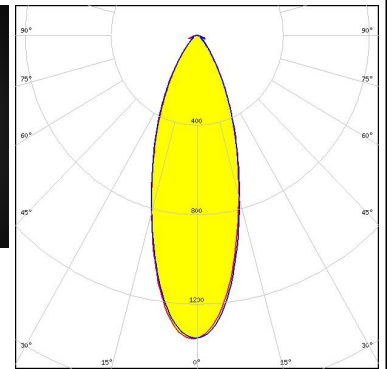
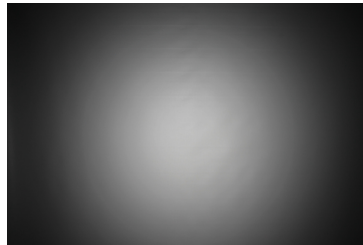

CREE

LED CMA1516
 FWHM / FWTM 30.0° / 77.0°
 Efficiency 85 %
 Peak intensity 1.8 cd/lm
 LEDs/each optic 1
 Light colour White
 Required components:
 F15256_HEKLA-SOCKET-D

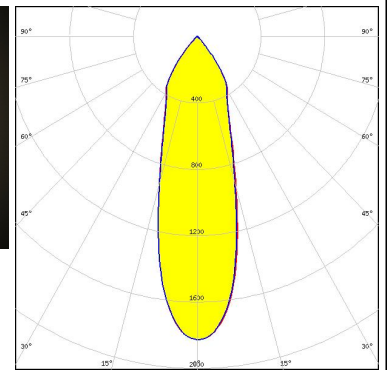
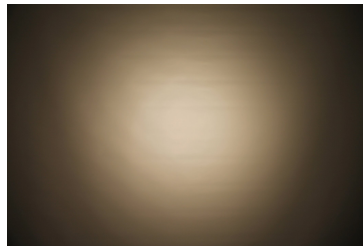

CREE

LED CMT14xx
 FWHM / FWTM 31.0° / 77.0°
 Efficiency 85 %
 Peak intensity 1.8 cd/lm
 LEDs/each optic 1
 Light colour White
 Required components:
 F15255_HEKLA-SOCKET-C

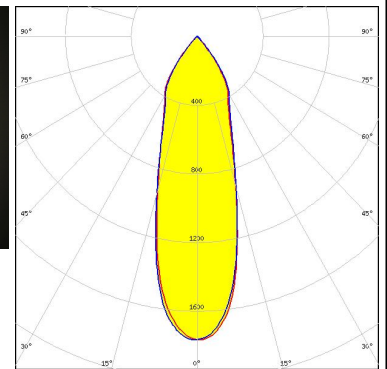
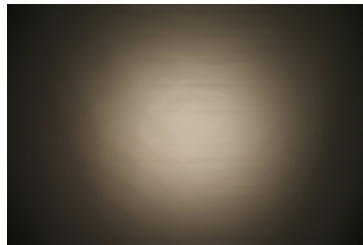

CREE

LED CXA/B 13xx
 FWHM / FWTM 20.0° / 66.0°
 Efficiency 90 %
 Peak intensity 3.4 cd/lm
 LEDs/each optic 1
 Light colour White
 Required components:
 F15956_HEKLA-SOCKET-J

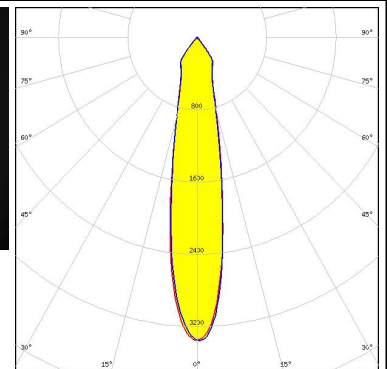

PHOTOMETRIC DATA (MEASURED):



LED CXA/B 13xx
 FWHM / FWTM 19.0° / 50.0°
 Efficiency 91 %
 Peak intensity 4.1 cd/lm
 LEDs/each optic 1
 Light colour White
 Required components:
 F15956_HEKLA-SOCKET-J
 C13333_MIRELLA-CL

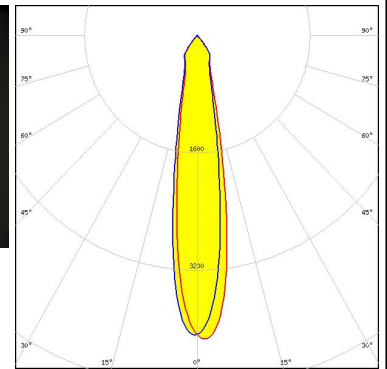

LED CXA/B 15xx
 FWHM / FWTM 25.0° / 67.0°
 Efficiency 91 %
 Peak intensity 2.9 cd/lm
 LEDs/each optic 1
 Light colour White
 Required components:
 F15256_HEKLA-SOCKET-D

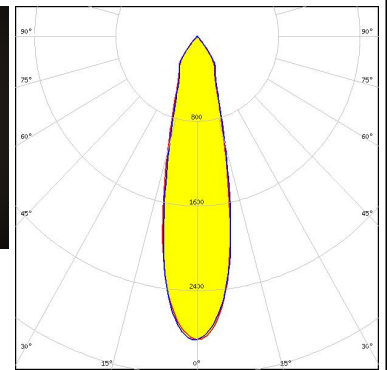
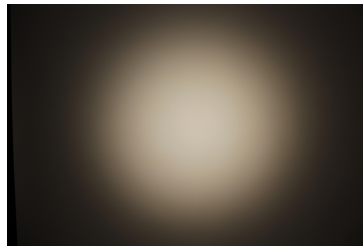

LED LUXEON CoB 1202/1203
 FWHM / FWTM 27.0° / 71.0°
 Efficiency 89 %
 Peak intensity 2.5 cd/lm
 LEDs/each optic 1
 Light colour White
 Required components:
 F15858_HEKLA-SOCKET-H
 C12479_MIRELLA-DL

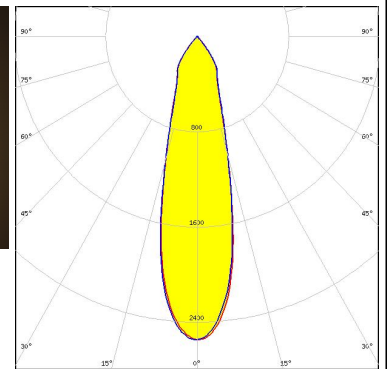
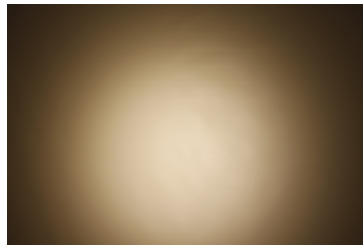

LED LUXEON CoB 1202/1203
 FWHM / FWTM 27.0° / 71.0°
 Efficiency 89 %
 Peak intensity 2.5 cd/lm
 LEDs/each optic 1
 Light colour White
 Required components:
 F15858_HEKLA-SOCKET-H

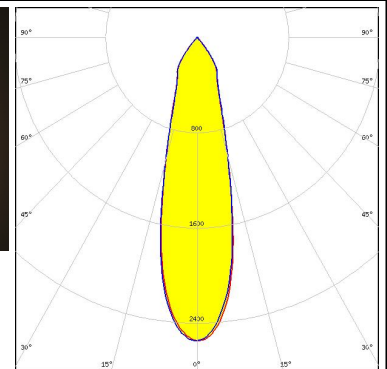
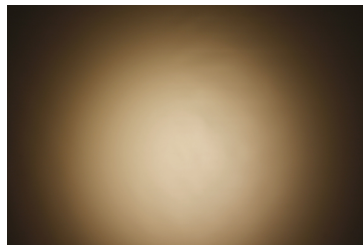

PHOTOMETRIC DATA (MEASURED):

LUMILEDS

LED LUXEON CoB 1202HD
 FWHM / FWTM 23.0° / 74.0°
 Efficiency 85 %
 Peak intensity 2.5 cd/lm
 LEDs/each optic 1
 Light colour White
 Required components:
 F15848_HEKLA-SOCKET-G

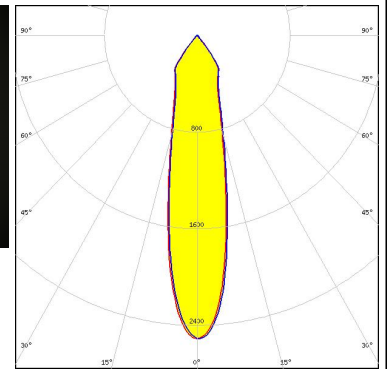
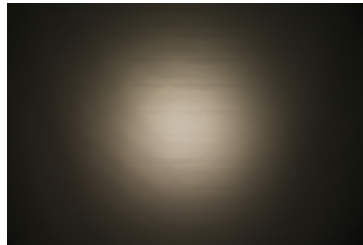

LUMILEDS

LED LUXEON CoB 1204HD
 FWHM / FWTM 29.0° / 77.0°
 Efficiency 85 %
 Peak intensity 1.9 cd/lm
 LEDs/each optic 1
 Light colour White
 Required components:
 F15858_HEKLA-SOCKET-H

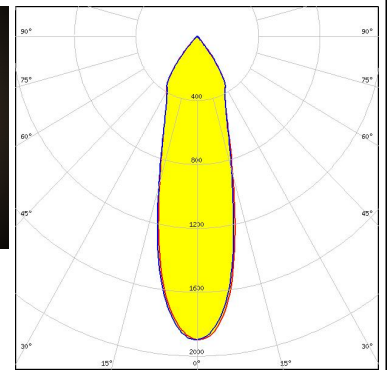
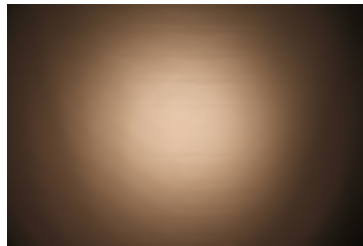

LUMILEDS

LED LUXEON CoB 1205HD
 FWHM / FWTM 35.0° / 79.0°
 Efficiency 83 %
 Peak intensity 1.5 cd/lm
 LEDs/each optic 1
 Light colour White
 Required components:
 F15858_HEKLA-SOCKET-H

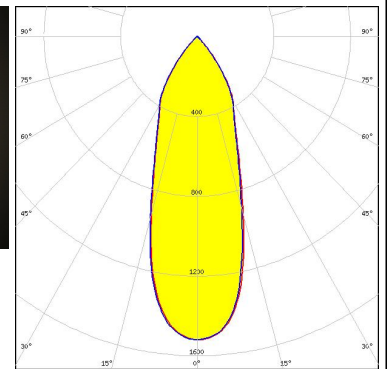
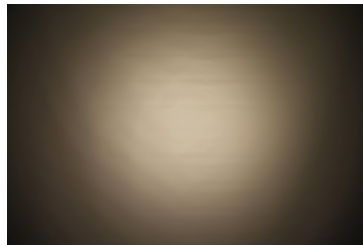





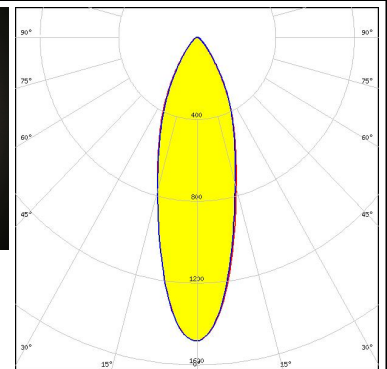
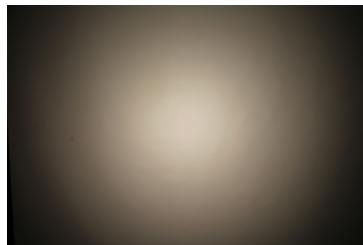

LUMILEDS

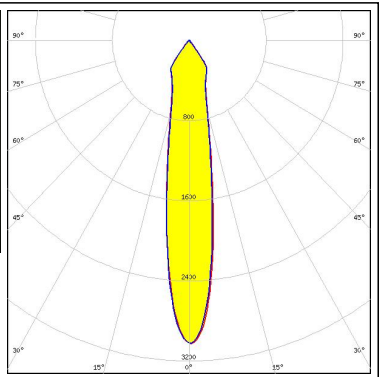

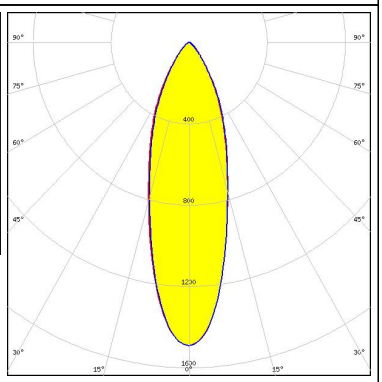

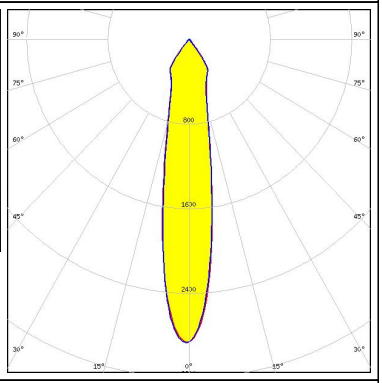

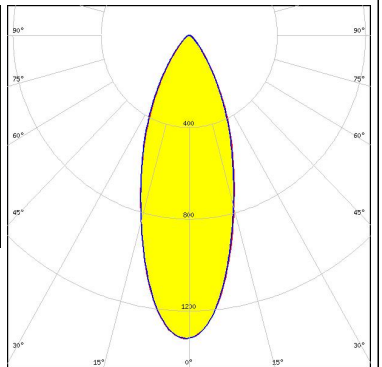
LED LUXEON CX Plus CoB - HD S01H4
 FWHM / FWTM 31.0° / 74.0°
 Efficiency 74 %
 Peak intensity 1.5 cd/lm
 LEDs/each optic 1
 Light colour White
 Required components:
 C13723_MIRELLA-RZL
 Bender Wirth: 634c Hekla



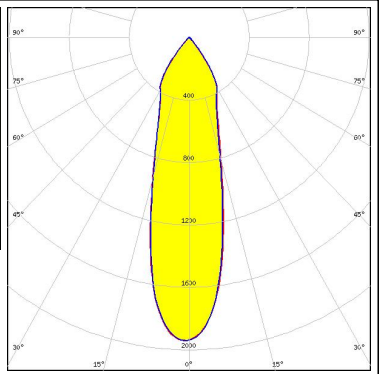

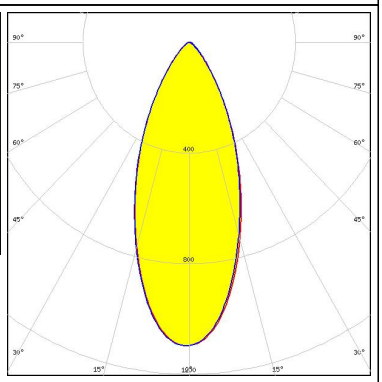
PHOTOMETRIC DATA (MEASURED):

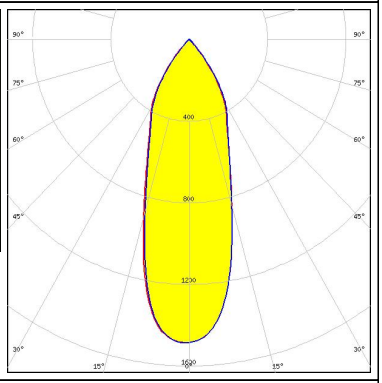
<p>LUMILEDS</p> <p>LED LUXEON CX Plus CoB - HD S01H4</p> <p>FWHM / FWTM 19.0° / 70.0°</p> <p>Efficiency 81 %</p> <p>Peak intensity 3 cd/lm</p> <p>LEDs/each optic 1</p> <p>Light colour White</p> <p>Required components: Bender Wirth: 634c Hekla</p>		
<p>LUMILEDS</p> <p>LED LUXEON CX Plus CoB - HD S01H6 / HD S02H6</p> <p>FWHM / FWTM 32.0° / 74.0°</p> <p>Efficiency 74 %</p> <p>Peak intensity 1.5 cd/lm</p> <p>LEDs/each optic 1</p> <p>Light colour White</p> <p>Required components: C13723_MIRELLA-RZL Bender Wirth: 634c Hekla</p>		
<p>LUMILEDS</p> <p>LED LUXEON CX Plus CoB - HD S01H6 / HD S02H6</p> <p>FWHM / FWTM 19.0° / 71.0°</p> <p>Efficiency 81 %</p> <p>Peak intensity 2.9 cd/lm</p> <p>LEDs/each optic 1</p> <p>Light colour White</p> <p>Required components: Bender Wirth: 634c Hekla</p>		
<p>LUMILEDS</p> <p>LED LUXEON CX Plus CoB - HD S04H9</p> <p>FWHM / FWTM 37.0° / 76.0°</p> <p>Efficiency 75 %</p> <p>Peak intensity 1.3 cd/lm</p> <p>LEDs/each optic 1</p> <p>Light colour White</p> <p>Required components: C13723_MIRELLA-RZL Bender Wirth: 634c Hekla</p>		

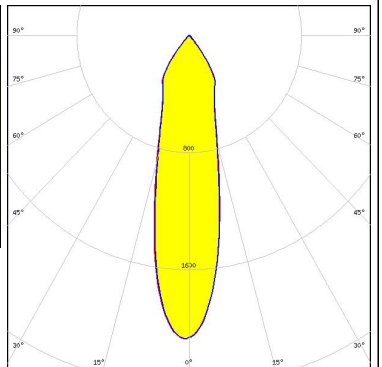
PHOTOMETRIC DATA (MEASURED):

<p>LUMILEDS</p> <p>LED LUXEON CX Plus CoB - HD S04H9</p> <p>FWHM / FWTM 28.0° / 75.0°</p> <p>Efficiency 82 %</p> <p>Peak intensity 1.9 cd/m</p> <p>LEDs/each optic 1</p> <p>Light colour White</p> <p>Required components: Bender Wirth: 634c Hekla</p>		
<p>LUMILEDS</p> <p>LED LUXEON CX Plus CoB L04 / L05 (Gen2)</p> <p>FWHM / FWTM 42.0° / 81.0°</p> <p>Efficiency 72 %</p> <p>Peak intensity 1.1 cd/m</p> <p>LEDs/each optic 1</p> <p>Light colour White</p> <p>Required components: C13723_MIRELLA-RZL Bender Wirth: 637a Hekla</p>		
<p>LUMILEDS</p> <p>LED LUXEON CX Plus CoB L04 / L05 (Gen2)</p> <p>FWHM / FWTM 35.0° / 78.0°</p> <p>Efficiency 80 %</p> <p>Peak intensity 1.5 cd/m</p> <p>LEDs/each optic 1</p> <p>Light colour White</p> <p>Required components: Bender Wirth: 637a Hekla</p>		
<p>LUMILEDS</p> <p>LED LUXEON CX Plus CoB M02 / M03 (Gen2)</p> <p>FWHM / FWTM 25.0° / 74.0°</p> <p>Efficiency 80 %</p> <p>Peak intensity 2.1 cd/m</p> <p>LEDs/each optic 1</p> <p>Light colour White</p> <p>Required components: Bender Wirth: 641a Hekla</p>		

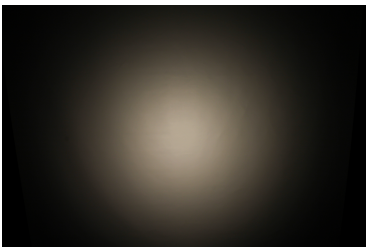
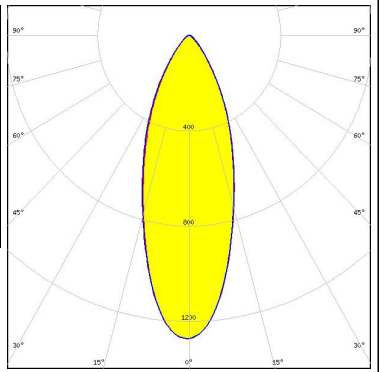
PHOTOMETRIC DATA (MEASURED):

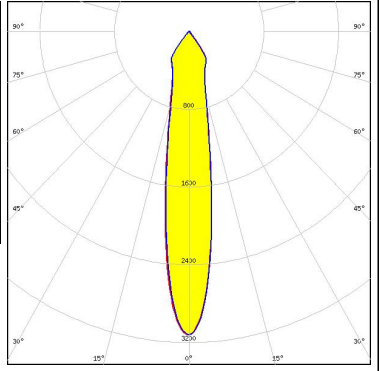
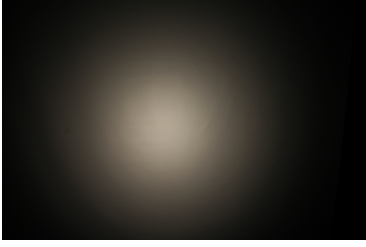
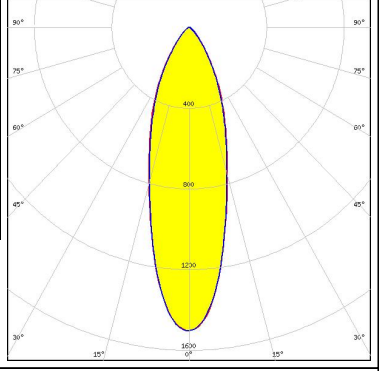
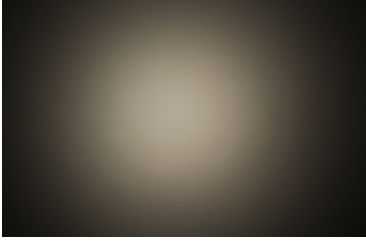
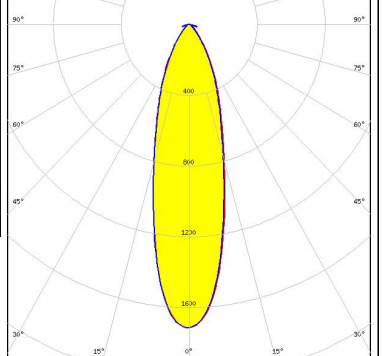
<p>LUMILEDS</p> <p>LED LUXEON CX Plus CoB M02 / M03 (Gen2)</p> <p>FWHM / FWTM 37.0° / 77.0°</p> <p>Efficiency 73 %</p> <p>Peak intensity 1.3 cd/lm</p> <p>LEDs/each optic 1</p> <p>Light colour White</p> <p>Required components: C13723_MIRELLA-RZL Bender Wirth: 641a Hekla</p>		
<p>LUMILEDS</p> <p>LED LUXEON CX Plus CoB S01 (Gen2)</p> <p>FWHM / FWTM 18.0° / 69.0°</p> <p>Efficiency 81 %</p> <p>Peak intensity 3.1 cd/lm</p> <p>LEDs/each optic 1</p> <p>Light colour White</p> <p>Required components: Bender Wirth: 634c Hekla</p>		
<p>LUMILEDS</p> <p>LED LUXEON CX Plus CoB S01 (Gen2)</p> <p>FWHM / FWTM 31.0° / 73.0°</p> <p>Efficiency 74 %</p> <p>Peak intensity 1.5 cd/lm</p> <p>LEDs/each optic 1</p> <p>Light colour White</p> <p>Required components: C13723_MIRELLA-RZL Bender Wirth: 634c Hekla</p>		
<p>LUMINUS</p> <p>LED CDM-6 (Dim-To-Warm)</p> <p>FWHM / FWTM 28.0° / 68.0°</p> <p>Efficiency 75 %</p> <p>Peak intensity 1.7 cd/lm</p> <p>LEDs/each optic 1</p> <p>Light colour White</p> <p>Required components: C16142_HEKLA-SOCKET-K C13723_MIRELLA-RZL Bender Wirth: 490 Typ L8</p>		

PHOTOMETRIC DATA (MEASURED):



LED CDM-6 (Dim-To-Warm)
 FWHM / FWTM 20.0° / 60.0°
 Efficiency 82 %
 Peak intensity 3.2 cd/lm
 LEDs/each optic 1
 Light colour White
 Required components:
 C16142_HEKLA-SOCKET-K
 Bender Wirth: 490 Typ L8

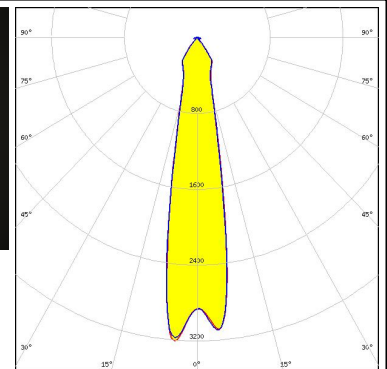

LED CDM-9 (Dim-To-Warm)
 FWHM / FWTM 32.0° / 71.0°
 Efficiency 74 %
 Peak intensity 1.5 cd/lm
 LEDs/each optic 1
 Light colour White
 Required components:
 C16142_HEKLA-SOCKET-K
 C13723_MIRELLA-RZL
 Bender Wirth: 490 Typ L8

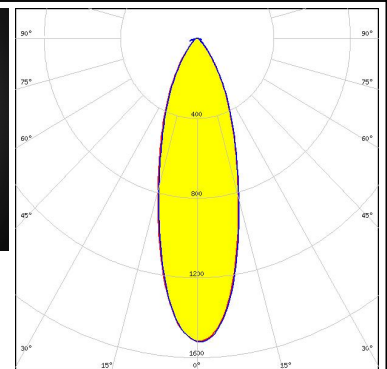
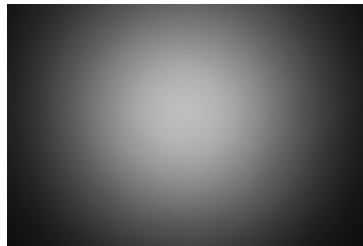



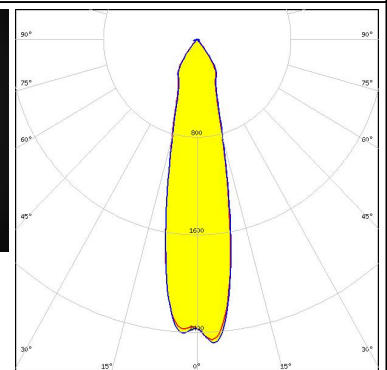
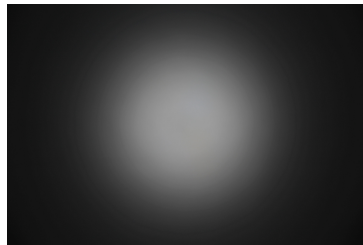

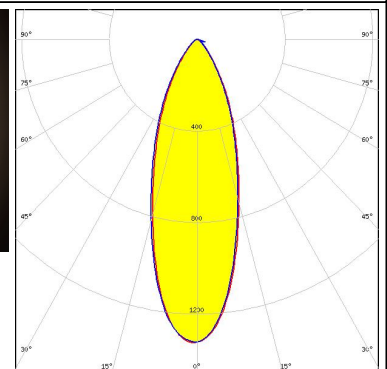
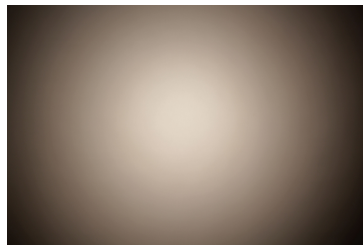

LED CDM-9 (Dim-To-Warm)
 FWHM / FWTM 24.0° / 69.0°
 Efficiency 81 %
 Peak intensity 2.5 cd/lm
 LEDs/each optic 1
 Light colour White
 Required components:
 C16142_HEKLA-SOCKET-K
 Bender Wirth: 490 Typ L8



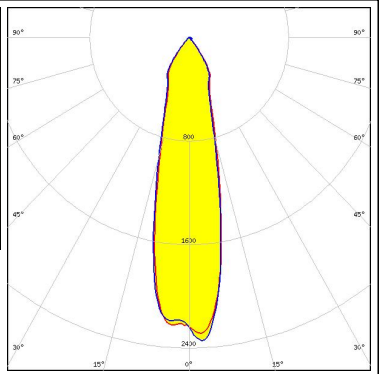

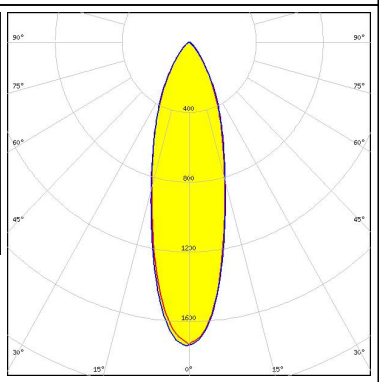

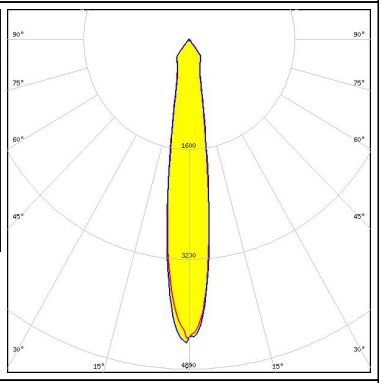

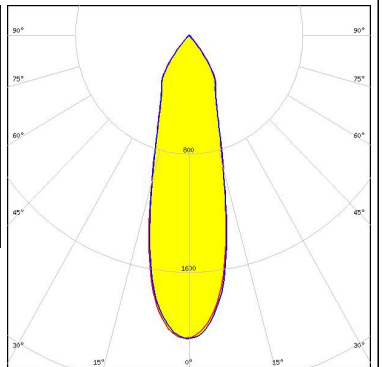
LED CTM-9 (Tunable White)
 FWHM / FWTM 34.0° / 75.0°
 Efficiency 72 %
 Peak intensity 1.3 cd/lm
 LEDs/each optic 1
 Light colour White
 Required components:
 C16142_HEKLA-SOCKET-K
 C13723_MIRELLA-RZL
 Bender Wirth: 495 Typ L8

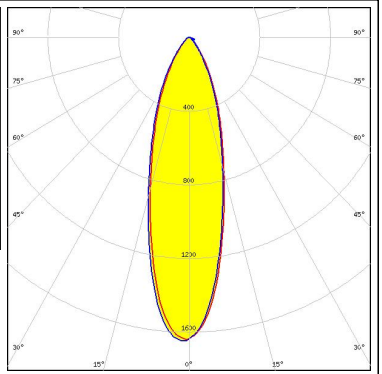

PHOTOMETRIC DATA (MEASURED):

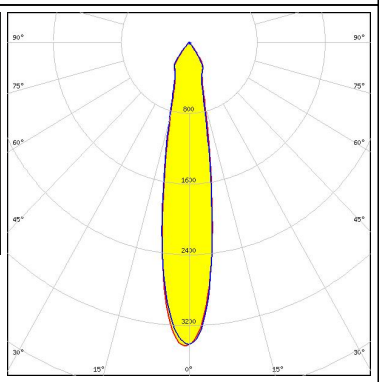
<p>LUMINUS</p> <p>LED CTM-9 (Tunable White)</p> <p>FWHM / FWTM 25.0° / 70.0°</p> <p>Efficiency 80 %</p> <p>Peak intensity 2.4 cd/lm</p> <p>LEDs/each optic 1</p> <p>Light colour White</p> <p>Required components: C16142_HEKLA-SOCKET-K Bender Wirth: 495 Typ L8</p>		
<p>LUMINUS</p> <p>LED CXM-4</p> <p>FWHM / FWTM 29.0° / 71.0°</p> <p>Efficiency 79 %</p> <p>Peak intensity 1.7 cd/lm</p> <p>LEDs/each optic 1</p> <p>Light colour White</p> <p>Required components: F15255_HEKLA-SOCKET-C C13723_MIRELLA-RZL</p>		
<p>LUMINUS</p> <p>LED CXM-4</p> <p>FWHM / FWTM 16.0° / 46.0°</p> <p>Efficiency 87 %</p> <p>Peak intensity 4.4 cd/lm</p> <p>LEDs/each optic 1</p> <p>Light colour White</p> <p>Required components: F15255_HEKLA-SOCKET-C</p>		
<p>LUMINUS</p> <p>LED CxM-9 (13.5x13.5)</p> <p>FWHM / FWTM 29.0° / 75.0°</p> <p>Efficiency 87 %</p> <p>Peak intensity 2.1 cd/lm</p> <p>LEDs/each optic 1</p> <p>Light colour White</p> <p>Required components: F15255_HEKLA-SOCKET-C</p>		

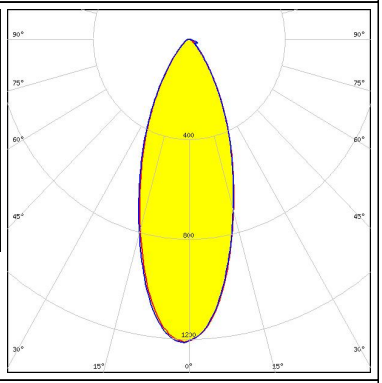
PHOTOMETRIC DATA (MEASURED):

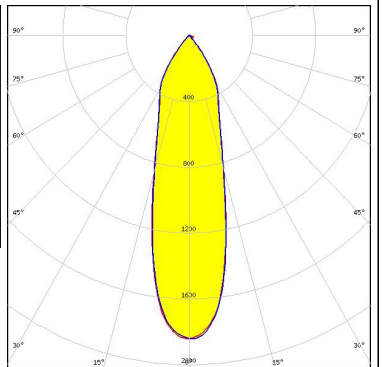
<p>NICHIA</p> <p>LED NJCWL024Z-V1MT: COB L-Type Tunable White</p> <p>FWHM / FWTM 30.0° / 69.0°</p> <p>Efficiency 74 %</p> <p>Peak intensity 1.7 cd/lm</p> <p>LEDs/each optic 1</p> <p>Light colour White</p> <p>Required components:</p> <ul style="list-style-type: none"> C16142_HEKLA-SOCKET-K C13723_MIRELLA-RZL <p>Bender Wirth: 497 Typ L8</p>		
<p>NICHIA</p> <p>LED NJCWL024Z-V1MT: COB L-Type Tunable White</p> <p>FWHM / FWTM 19.0° / 58.0°</p> <p>Efficiency 82 %</p> <p>Peak intensity 3.4 cd/lm</p> <p>LEDs/each optic 1</p> <p>Light colour White</p> <p>Required components:</p> <ul style="list-style-type: none"> C16142_HEKLA-SOCKET-K <p>Bender Wirth: 497 Typ L8</p>		
<p>NICHIA</p> <p>LED NVCWJ024Z-V1MT: COB J-Type Tunable White</p> <p>FWHM / FWTM 37.0° / 77.0°</p> <p>Efficiency 73 %</p> <p>Peak intensity 1.2 cd/lm</p> <p>LEDs/each optic 1</p> <p>Light colour White</p> <p>Required components:</p> <ul style="list-style-type: none"> C16142_HEKLA-SOCKET-K C13723_MIRELLA-RZL <p>Bender Wirth: 498 Typ L8</p>		
<p>NICHIA</p> <p>LED NVCWJ024Z-V1MT: COB J-Type Tunable White</p> <p>FWHM / FWTM 28.0° / 73.0°</p> <p>Efficiency 80 %</p> <p>Peak intensity 1.8 cd/lm</p> <p>LEDs/each optic 1</p> <p>Light colour White</p> <p>Required components:</p> <ul style="list-style-type: none"> C16142_HEKLA-SOCKET-K <p>Bender Wirth: 498 Typ L8</p>		

PHOTOMETRIC DATA (MEASURED):

OSRAM

Opto Semiconductors

LED Soleriq S9
 FWHM / FWTM 28.0° / 71.0°
 Efficiency 90 %
 Peak intensity 2.4 cd/lm
 LEDs/each optic 1
 Light colour White
 Required components:
 F15255_HEKLA-SOCKET-C

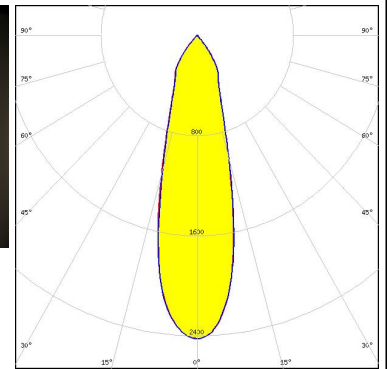

OSRAM

Opto Semiconductors

LED Soleriq S9
 FWHM / FWTM 28.0° / 71.0°
 Efficiency 90 %
 Peak intensity 2.4 cd/lm
 LEDs/each optic 1
 Light colour White
 Required components:
 F15255_HEKLA-SOCKET-C
 C13723_MIRELLA-RZL

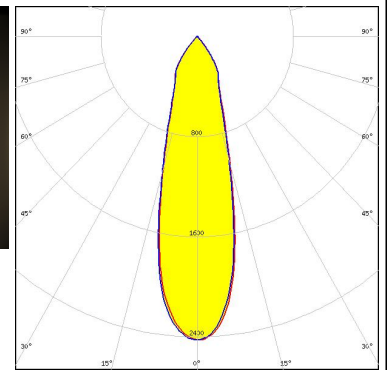

PHILIPS

LED Fortimo SLM L09 CoB
 FWHM / FWTM 39.0° / 78.0°
 Efficiency 75 %
 Peak intensity 1.2 cd/lm
 LEDs/each optic 1
 Light colour White
 Required components:
 F15858_HEKLA-SOCKET-H
 C13723_MIRELLA-RZL

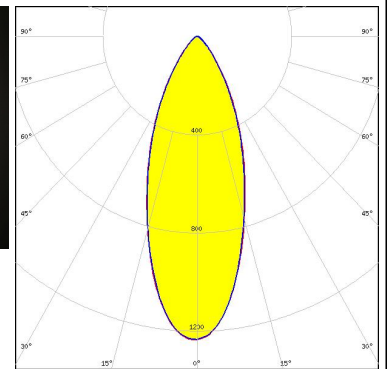
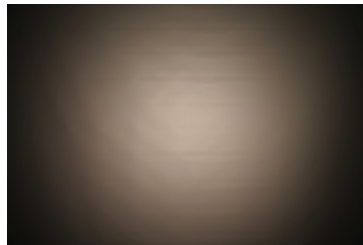

PHILIPS

LED Fortimo SLM L09 CoB
 FWHM / FWTM 29.0° / 77.0°
 Efficiency 83 %
 Peak intensity 1.8 cd/lm
 LEDs/each optic 1
 Light colour White
 Required components:
 F15858_HEKLA-SOCKET-H

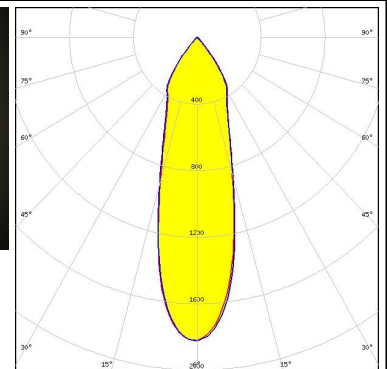
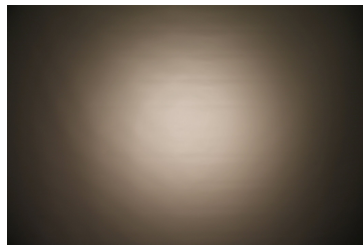

PHOTOMETRIC DATA (MEASURED):

PHILIPS

LED Fortimo SLM L13 CoB
 FWHM / FWTM 45.0° / 82.0°
 Efficiency 71 %
 Peak intensity 1 cd/lm
 LEDs/each optic 1
 Light colour White
 Required components:
 C16142_HEKLA-SOCKET-K
 C13723_MIRELLA-RZL
 Bender Wirth: 432 Typ L8

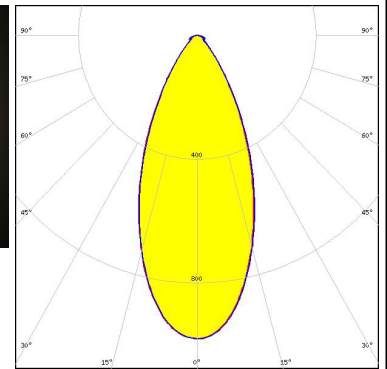
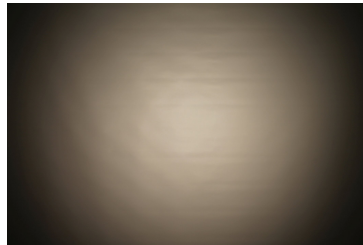

PHILIPS

LED Fortimo SLM L13 CoB
 FWHM / FWTM 40.0° / 80.0°
 Efficiency 77 %
 Peak intensity 1.2 cd/lm
 LEDs/each optic 1
 Light colour White
 Required components:
 C16142_HEKLA-SOCKET-K
 Bender Wirth: 432 Typ L8

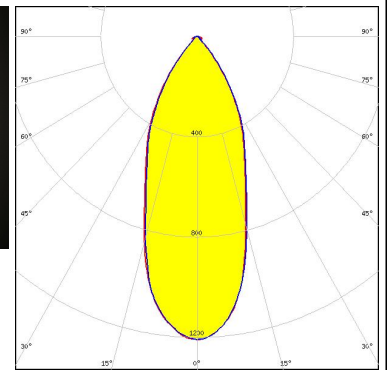
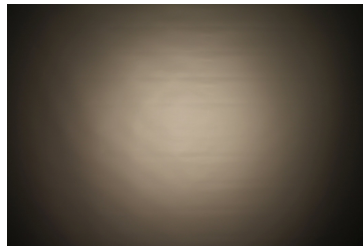

PHILIPS

LED Fortimo SLM L13 CoB
 FWHM / FWTM 40.0° / 80.0°
 Efficiency 77 %
 Peak intensity 1.2 cd/lm
 LEDs/each optic 1
 Light colour White
 Required components:
 C16142_HEKLA-SOCKET-K
 Bender Wirth: 432 Typ L8

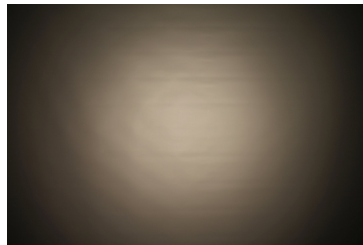

PHILIPS

LED Fortimo SLM L13 CoB
 FWHM / FWTM 45.0° / 82.0°
 Efficiency 71 %
 Peak intensity 1 cd/lm
 LEDs/each optic 1
 Light colour White
 Required components:
 C16142_HEKLA-SOCKET-K
 C13723_MIRELLA-RZL
 Bender Wirth: 432 Typ L8

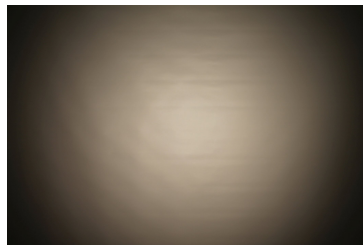

PHOTOMETRIC DATA (MEASURED):

SAMSUNG

LED LC010C G2
 FWHM / FWTM 19.0° / 65.0°
 Efficiency 86 %
 Peak intensity 3.4 cd/lm
 LEDs/each optic 1
 Light colour White
 Required components:
 F15255_HEKLA-SOCKET-C

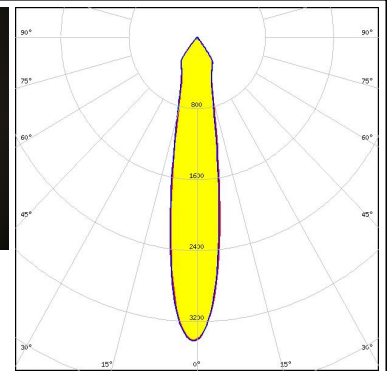

SAMSUNG

LED LC010T (Tunable White)
 FWHM / FWTM 27.0° / 69.0°
 Efficiency 76 %
 Peak intensity 2 cd/lm
 LEDs/each optic 1
 Light colour White
 Required components:
 C16142_HEKLA-SOCKET-K
 C14658_BARBARA-RZ-LENS
 Bender Wirth: 501 Typ L8

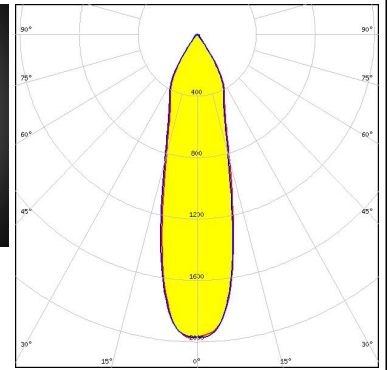
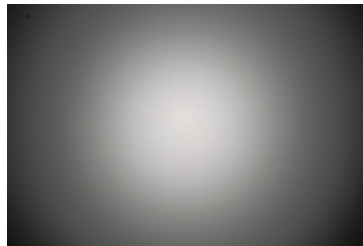

SAMSUNG

LED LC010T (Tunable White)
 FWHM / FWTM 26.0° / 72.0°
 Efficiency 81 %
 Peak intensity 2.2 cd/lm
 LEDs/each optic 1
 Light colour Tunable White
 Required components:
 C16142_HEKLA-SOCKET-K
 Bender Wirth: 501 Typ L8

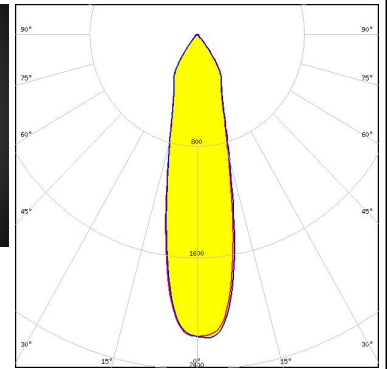
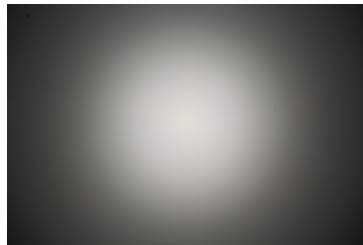

SAMSUNG

LED LC016D / LC019D / LC026D / LC033D
 FWHM / FWTM 44.0° / 82.0°
 Efficiency 83 %
 Peak intensity 1.2 cd/lm
 LEDs/each optic 1
 Light colour White
 Required components:
 F15859_HEKLA-SOCKET-I

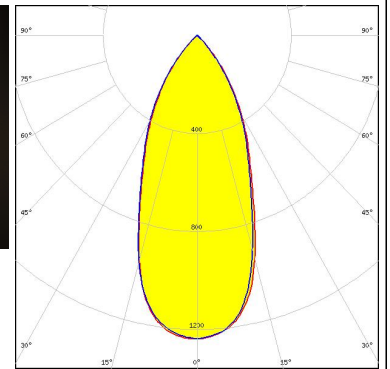
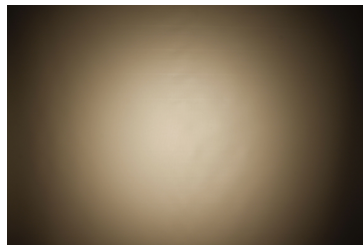

PHOTOMETRIC DATA (MEASURED):

SAMSUNG

LED LC016D / LC019D / LC026D / LC033D
 FWHM / FWTM 47.0° / 85.0°
 Efficiency 74 %
 Peak intensity 1 cd/lm
 LEDs/each optic 1
 Light colour White
 Required components:
 F15859_HEKLA-SOCKET-I
 C13723_MIRELLA-RZL

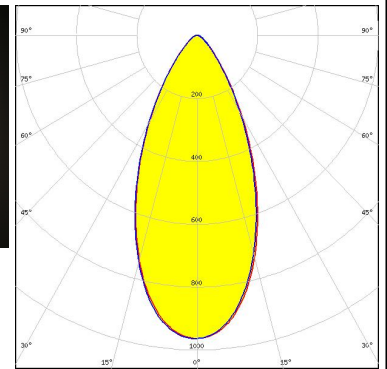

SAMSUNG

LED LC016D / LC019D / LC026D / LC033D
 FWHM / FWTM 47.0° / 79.0°
 Efficiency 79 %
 Peak intensity 1.2 cd/lm
 LEDs/each optic 1
 Light colour White
 Required components:
 C15570_LENA-STD-BASE2-VERO13-18
 C13333_MIRELLA-CL

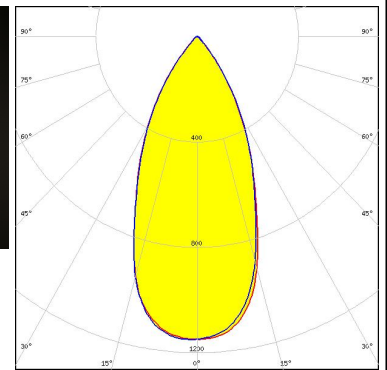
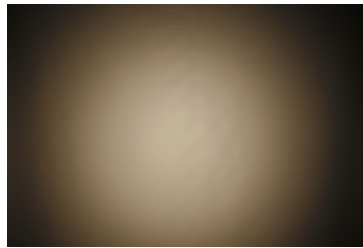

SAMSUNG

LED LC016D / LC019D / LC026D / LC033D
 FWHM / FWTM 47.0° / 81.0°
 Efficiency 77 %
 Peak intensity 1.1 cd/lm
 LEDs/each optic 1
 Light colour White
 Required components:
 F15859_HEKLA-SOCKET-I
 C12479_MIRELLA-DL

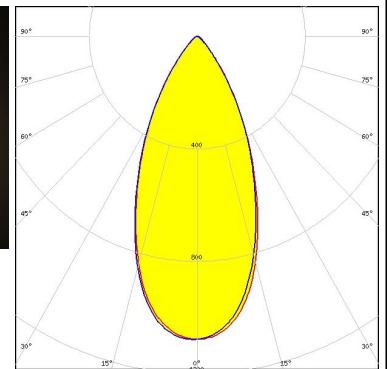
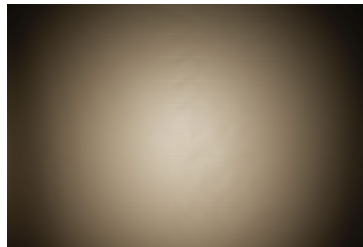

SAMSUNG

LED LC020C
 FWHM / FWTM 25.0° / 73.0°
 Efficiency 88 %
 Peak intensity 2.5 cd/lm
 LEDs/each optic 1
 Light colour White
 Required components:
 F15848_HEKLA-SOCKET-G

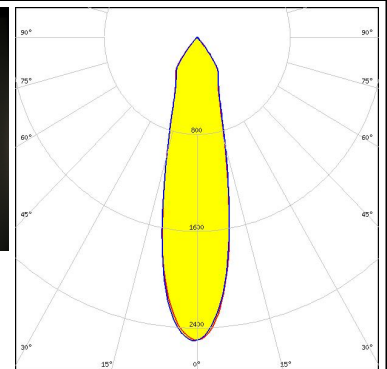

PHOTOMETRIC DATA (MEASURED):

SAMSUNG

LED LC020C G2
 FWHM / FWTM 27.0° / 74.0°
 Efficiency 85 %
 Peak intensity 2.2 cd/lm
 LEDs/each optic 1
 Light colour White
 Required components:
 F15859_HEKLA-SOCKET-I

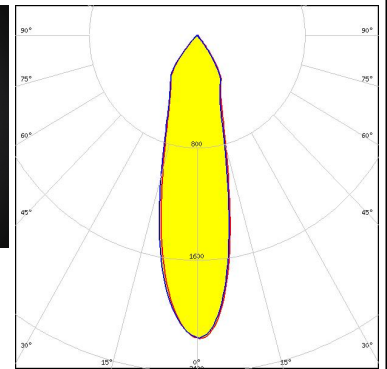
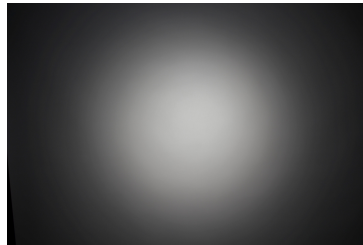

TRIDONIC

LED SLE G7 LES09
 FWHM / FWTM 36.0° / 75.0°
 Efficiency 82 %
 Peak intensity 1.5 cd/lm
 LEDs/each optic 1
 Light colour White
 Required components:
 F15255_HEKLA-SOCKET-C
 C13723_MIRELLA-RZL

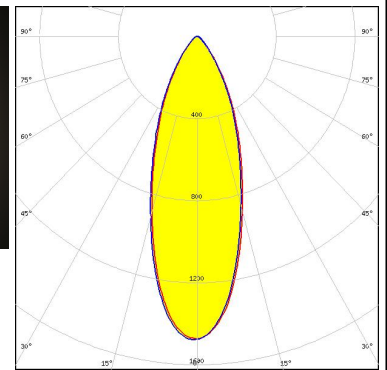
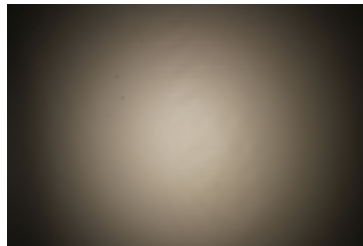

TRIDONIC

LED SLE G7 LES09
 FWHM / FWTM 27.0° / 73.0°
 Efficiency 89 %
 Peak intensity 2.3 cd/lm
 LEDs/each optic 1
 Light colour White
 Required components:
 F15255_HEKLA-SOCKET-C

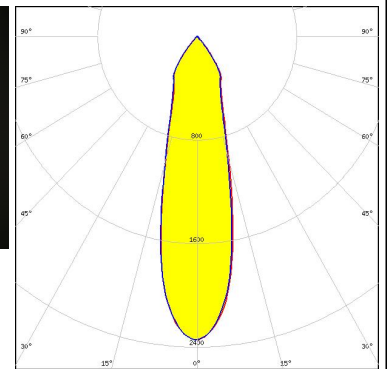
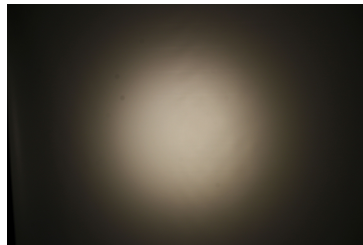

TRIDONIC

LED SLE G7 LES13
 FWHM / FWTM 44.0° / 82.0°
 Efficiency 76 %
 Peak intensity 1.1 cd/lm
 LEDs/each optic 1
 Light colour White
 Required components:
 F15859_HEKLA-SOCKET-I
 C13723_MIRELLA-RZL

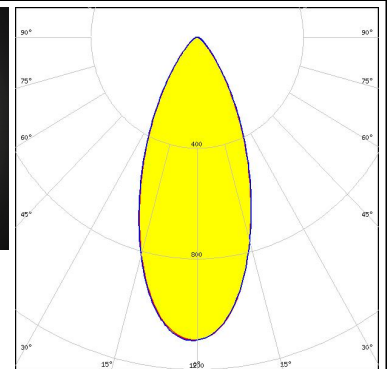
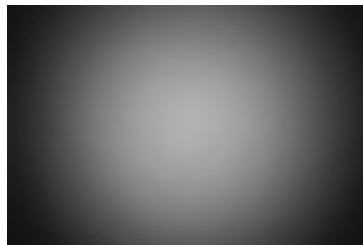

PHOTOMETRIC DATA (MEASURED):

TRIDONIC

LED SLE G7 LES13
 FWHM / FWTM 39.0° / 80.0°
 Efficiency 84 %
 Peak intensity 1.4 cd/lm
 LEDs/each optic 1
 Light colour White
 Required components:
 F15859_HEKLA-SOCKET-I

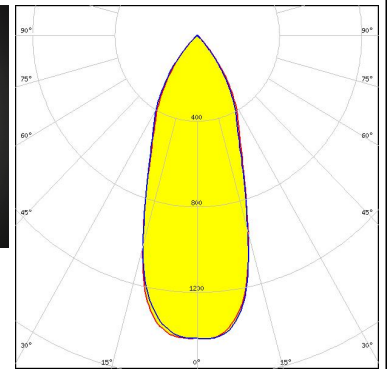
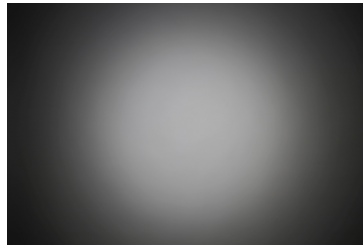

XICATO

LED XOB 14.5 mm
 FWHM / FWTM 46.0° / 84.0°
 Efficiency 77 %
 Peak intensity 1.1 cd/lm
 LEDs/each optic 1
 Light colour White
 Required components:
 F15859_HEKLA-SOCKET-I
 C13723_MIRELLA-RZL

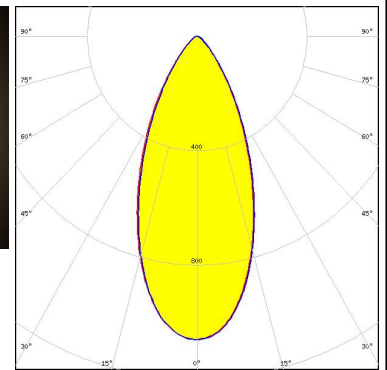
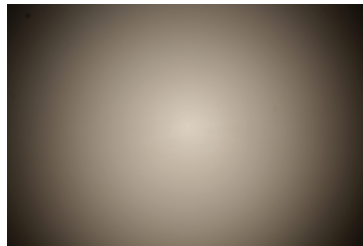

XICATO

LED XOB 14.5 mm
 FWHM / FWTM 42.0° / 81.0°
 Efficiency 84 %
 Peak intensity 1.3 cd/lm
 LEDs/each optic 1
 Light colour White
 Required components:
 F15859_HEKLA-SOCKET-I

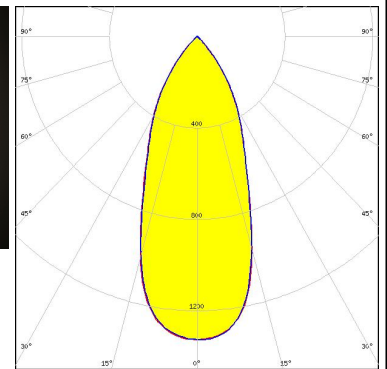
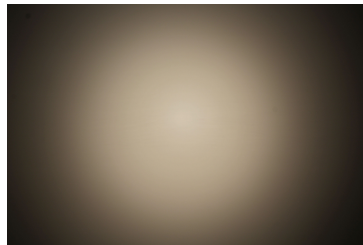

XICATO

LED XOB 6 mm
 FWHM / FWTM 31.0° / 72.0°
 Efficiency 80 %
 Peak intensity 1.6 cd/lm
 LEDs/each optic 1
 Light colour White
 Required components:
 F15255_HEKLA-SOCKET-C
 C13723_MIRELLA-RZL

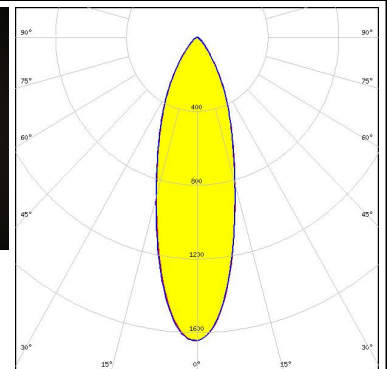
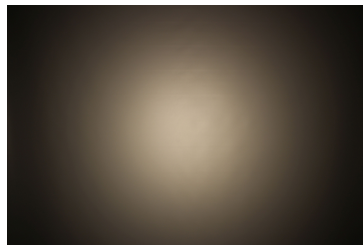

PHOTOMETRIC DATA (MEASURED):

XICATO

LED XOB 6 mm
 FWHM / FWTM 20.0° / 65.0°
 Efficiency 87 %
 Peak intensity 3.4 cd/lm
 LEDs/each optic 1
 Light colour White
 Required components:
 F15255_HEKLA-SOCKET-C

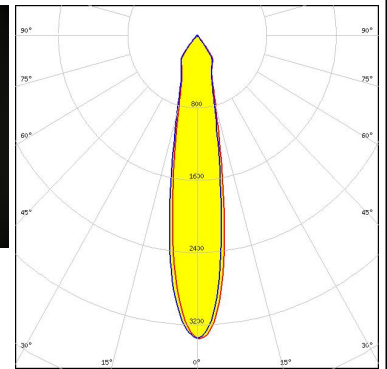

XICATO

LED XOB 9.8 mm
 FWHM / FWTM 36.0° / 76.0°
 Efficiency 80 %
 Peak intensity 1.4 cd/lm
 LEDs/each optic 1
 Light colour White
 Required components:
 F15255_HEKLA-SOCKET-C
 C13723_MIRELLA-RZL

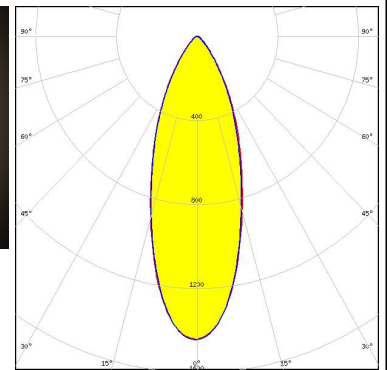

XICATO

LED XOB 9.8 mm
 FWHM / FWTM 27.0° / 74.0°
 Efficiency 88 %
 Peak intensity 2.3 cd/lm
 LEDs/each optic 1
 Light colour White
 Required components:
 F15255_HEKLA-SOCKET-C
 C13723_MIRELLA-RZL

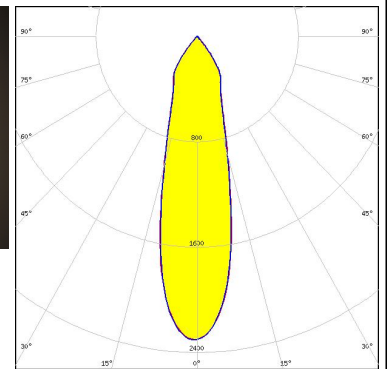
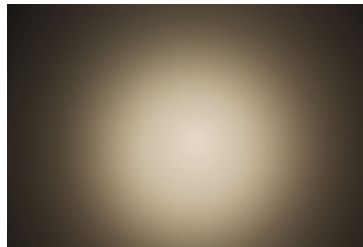

PHOTOMETRIC DATA (SIMULATED):

CITIZEN

LED CLL02x/CLU02x (LES10)
 FWHM / FWTM 27.3° / 65.3°
 Efficiency 87 %
 Peak intensity 2.7 cd/lm
 LEDs/each optic 1
 Light colour White
 Required components:
 F15255_HEKLA-SOCKET-C

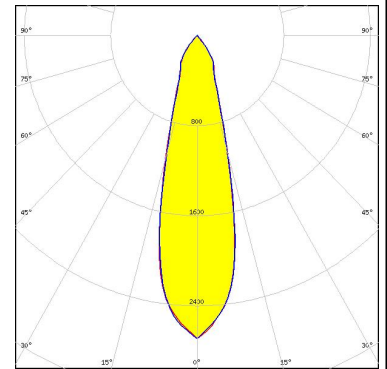

LUMILEDS

LED LUXEON M/MX
 FWHM / FWTM 20.0° / 41.0°
 Efficiency 89 %
 Peak intensity 4.4 cd/lm
 LEDs/each optic 1
 Light colour White
 Required components:
 F15255_HEKLA-SOCKET-C

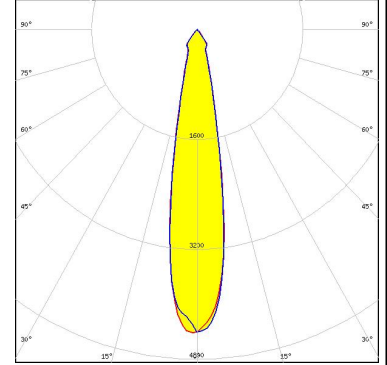

NICHIA

LED COB L-Type (LES 11)
 FWHM / FWTM 32.0° / 71.0°
 Efficiency 88 %
 Peak intensity 2.1 cd/lm
 LEDs/each optic 1
 Light colour White
 Required components:
 F15858_HEKLA-SOCKET-H

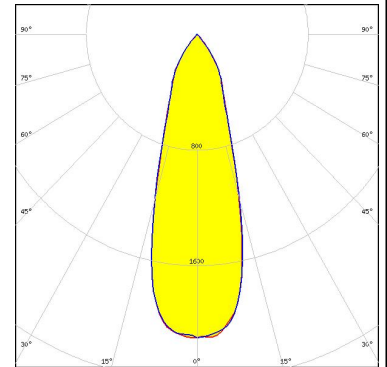

NICHIA

LED COB T-Type
 FWHM / FWTM 21.0° / 43.0°
 Efficiency 88 %
 Peak intensity 4 cd/lm
 LEDs/each optic 1
 Light colour White
 Required components:
 F15848_HEKLA-SOCKET-G

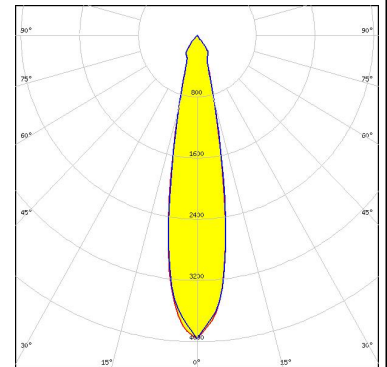

GENERAL INFORMATION:

NOTE: The typical beam angle will be changed by different color, chip size and chip position tolerance. The typical total beam angle is the full angle measured where the luminous intensity is half of the peak value.

Due to use of high power COB's with this product, special attention to proper thermal design is highly recommended. LEDiL has no liability for direct, indirect or consecutive damages arising from the LEDiL products being used outside of the recommended temperature range.

MATERIALS:

As part of our continuous research and improvement processes, and to ensure the best possible quality and availability of our products, LEDiL reserves the right to change material grades without notice.

PRODUCT DATA USER AGREEMENT AND DISCLAIMER:

The measured data in the provided downloadable LEDiL Product Datasheets and Mechanical 2D-Drawings is rounded and provided as reference for planning. LEDiL Oy's optical specifications have been verified by conducting performance testing of the products in accordance with the company's quality system. The reported data are averaged results of multiple measurements with typical variation. LEDiL Oy reserves the right to without prior notification make changes and improvements to its products.

LEDiL Oy assumes neither warranty, nor guarantee nor any other liability of any kind for the contents and correctness of the provided data. The provided data has been generated with highest diligence but the provided data may in reality not represent the complete possible variation range of all intrinsic parameters. Therefore, in certain cases a deviation from the provided data could occur.

LEDiL Oy reserves the right to undertake technical changes of its products without further notification which could lead to changes in the provided data. LEDiL Oy assumes no liability of any kind for the possible deviation from any provided data or any other damage resulting from the usage of the provided data.

The user agrees to this disclaimer and user agreement with the download or usage of the provided files.

LEDiL Oy

Joensuunkatu 13
FI-24240 SALO
Finland

LEDiL Inc.

228 West Page Street
Suite D
Sycamore IL 60178
USA

Ledil Optics Technology (Shenzhen) Co., Ltd.

405 , Block B
Casic Motor Building
Shenzhen 518057
P.R.CHINA

Local sales and technical support

[www.ledil.com/
where_to_buy](http://www.ledil.com/where_to_buy)

Shipping locations

Salo, Finland
Hong Kong, China

Distribution Partners

[www.ledil.com/
where_to_buy](http://www.ledil.com/where_to_buy)